

Pos. Nr. Pos.no.	Beschreibung Description	Art.-Nr. Art.no.	Preisgruppe Price bracket
23257	V 200		
23282	V 200		
23283	BR 220		
23285	BR 220		
1	Platine komplett Printed circuit assembly	87705	35
2	Puffer Buffer	88580	3
3	Inneneinrichtung Interior	93686	4
4	Teilesatz Part set	93682	22
5	Lichtabdeckung Light cover	93689	2
6	Drahtlampe 16V Light bulb 16V	108616	10
7	GF-Schraube M1,6x6 Screw M1,6x6	113069	2
8	Gehäuse kpl. Betr. Nr. 220 011-1 f. 23285 Body assembly no. 220 011-1 f. 23285	120626	60
9	Gehäuse kpl. Betr. Nr. V 200 038 f. 23282 Body assembly no. V 200 038 f. 23282	120630	60
10	Gehäuse kpl. Betr. Nr. V 200 026 f. 23257 Body assembly no. V 200 026 f. 23257	120632	60
11	Gehäuse kpl. Betr. Nr. 220 039-2 f. 23283 Body assembly no. 220 039-2 f. 23283	120634	60

Änderungen in Konstruktion und Ausführung vorbehalten
We reserve the right to change the construction and specification

Auflage 08/2006
Edition 08/2006

Best. Nr. 841987
Order no. 841987

Blatt 1481
Page 1481

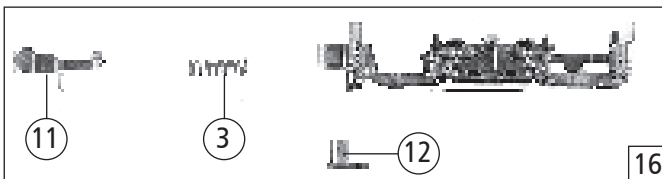
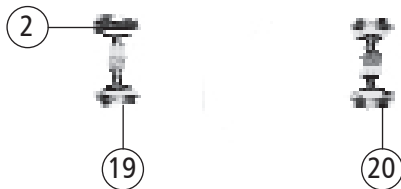
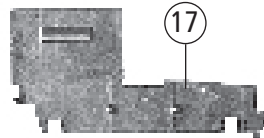
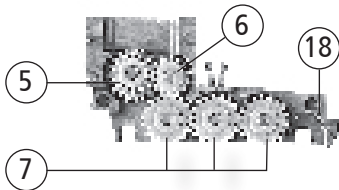
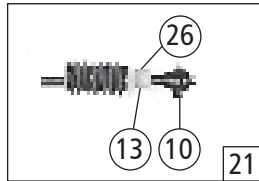
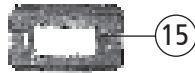
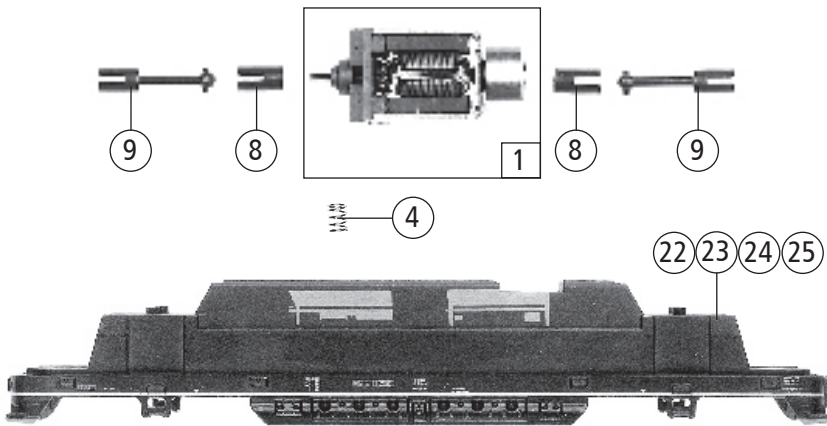

Pos. Nr. Pos.no.	Beschreibung Description	Art.-Nr. Art.no.	Preisgruppe Price bracket
23257	V 200		
23282	V 200		
23283	BR 220		
23285	BR 220		
1	Motor Motor	85121	57
2	Hafringesatz Traction tyre set	85609	---
3	Druckfeder Spring	86204	2
4	Druckfeder Spring	86209	2
5	Schneckenzahnrad Z=19/14 Worm Gear wheel Z=19/14	86400	3
6	Zahnrad Z=14 Gear wheel Z=14	86496	2
7	Achszahnrad Z=18 Axle gear wheel Z=18	86498	2
8	Kardanschale Cardan bearing	87104	3
9	Kardanwelle Cardan shaft	87105	3
10	Kardankugel Cardan ball	87106	2
11	Kupplung Coupling	89204	3
12	Kupplungsdeckel Coupling cover	89738	2
13	Schneckenachslager Worm axle bearing	89750	4
14	Radkontakt Wheel current contact strip	89881	2
15	Schneckendeckel Worm cover	93684	2
16	Drehgestellblende komplett Bogie frame assembly	93685	25
17	Getriebedeckel Gear cover	93687	12
18	Getriebe Gear box	93688	12
19	Radsatz mit Hafringen Wheelset with 2 traction tire	107333	18
20	Radsatz ohne Hafring Wheelset without traction tires	110822	16
21	Schneckensatz Worm set	113059	24
22	Lokunterteil f. 23285 Loco frame f. 23285	120627	25
23	Lokunterteil f. 23282 Loco frame f. 23282	120629	25
24	Lokunterteil f. 23257 Loco frame f. 23257	120631	25
25	Lokunterteil f. 23283 Loco frame f. 23283	120633	25
26	Scheibe 1,5x2,7x0,2 Washer 1,5x2,7x0,2	120735	2

Ersatzteile erhalten Sie bei Ihrem Fachhändler,
oder Ihrer Landesvertretung:

You can order your Replacement Parts at your
local dealer, your country representative: